

Cardrona Village Character Guideline

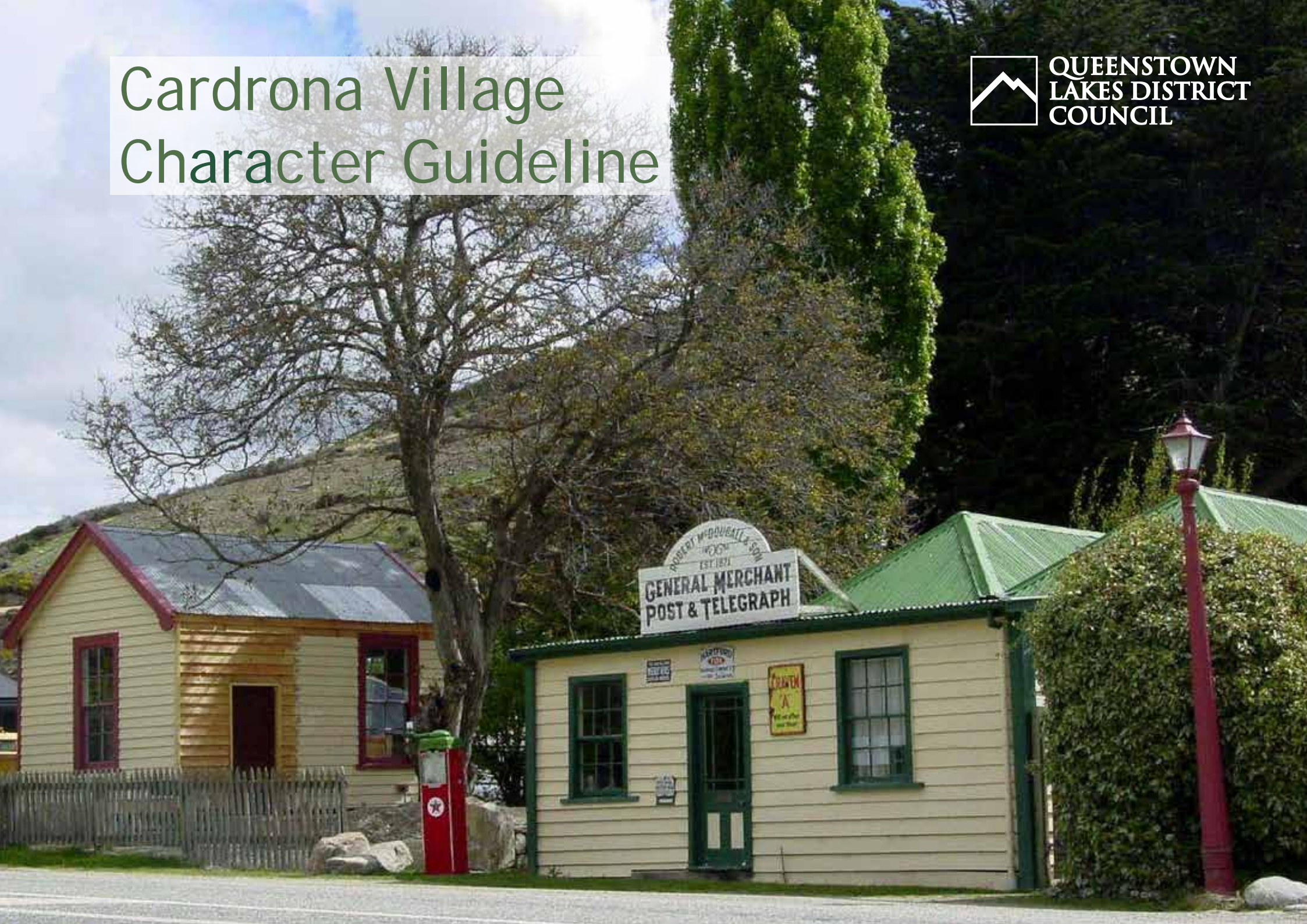

Contents

1	Introduction	1
	Purpose of the Guidelines.....	1
	Cardrona Village Characteristics.....	2
	Character Design Principles.....	4
2	Village Structure	6
	Structuring Elements	6
	Site Layout	9
3	Building Design Elements	12
	Building Character	12
	Materials	18
	Applying Colour	21
4	Public Open Space Design.....	22
	Cardrona Valley Road	22
	Village Green.....	25
	Secondary Streets and Lanes	26
	Riverside Landscape	27
	Landscaping and planting in Cardrona Village	28
	Palette of Materials	29

Acknowledgements

This guideline is produced by Queenstown Lakes District Council with support from Urbanism+ Ltd and Pocock Design:Environment

January 2012

1 Introduction

1.1 PURPOSE OF THE GUIDELINES

These Character Guidelines reflect the commitment of the Cardrona Valley community and the Queenstown Lakes District Council to encourage Cardrona Valley to develop as a cohesive and integrated Village with a character that is appropriate to its history and the surrounding environment.

To accomplish this, the guidelines identify the key existing characteristics that make Cardrona distinctive and suggest ways that the community can build upon and complement these characteristics as the village grows.

The guidelines are non statutory but are intended to complement and assist in the interpretation of the District Plan. To this end, the Council will use these guidelines under section 104(1)(c) of the Resource Management Act to help it assess and make decisions on resource consent applications.

The Council also recommends that all projects that will significantly affect the town or village centre are reviewed by the Urban Design Panel; which will consider how the proposal has applied these guidelines. The most value from the panel process usually arises when projects are brought to the panel in the conceptual stages of the project when the panel's advice can most readily be incorporated.





1.2 CARDRONA VILLAGE CHARACTERISTICS

The extraordinary natural environment (1), high country scenery, and the recreational activities based on this environment are qualities that attract recreational visitors and residents to the area. The village lies on the quickest route between Queenstown and Wanaka, close to the access roads to Cardrona Ski field, Snow Farm and Snow Park. The historic Cardrona Hotel remains an iconic stage post along that journey.

Development History

For centuries prior to European arrival the valley formed part of the route for Maori travelling between the West Coast and southern Otago. European settlement began with large pastoral runs back in the 1850s, followed rapidly by the discovery of gold in the 1860s which brought the influx of miners that led to the establishment of the town. At its peak in the 1870s, Cardrona is estimated to have had a population of between 3000 and 4000, with four hotels, three European stores, four Chinese stores, four butchers, a post office, bakery, blacksmith, bank, school, police headquarters and a jail. Despite only a few historic buildings surviving, the remnants of that era underpin the character of Cardrona today. Recent development is confined to a handful of houses and three clusters of visitor accommodation units

Landscape Setting

The Cardrona Valley is set in a high country alpine environment with development contained within the valley floor close to the Cardrona River (2). Here the environment has a more domesticated character, including plant species associated with farming and residential development. The village lies 25kms up the valley from Wanaka at a point where the wide open pastoral terraces of the valley floor transition to a narrower and more steeply inclined river valley, rising towards the Crown Range Pass. Crack Willows and Poplars are the dominant tree species in the valley, particularly below the village. A number of other large exotics are prominent around former and existing farm houses.

Within the town large specimen trees feature prominently, in some cases defining historic land uses in the absence of former buildings. The town's past is also reflected in the sluice faces visible around its edges. The close connection of the village to both its cultural and natural landscape setting is a key component to the Village Character.

The valley's flora features dramatic and attractive seasonal variation providing design cues for further planting as well as material and colour palettes.





Built Elements of the Village

The Cardrona Hotel (1) is the most significant remaining building from the gold rush era and provides the visual and functional focal point for the community. The simple rectangular façade and minor lean-to form an iconic frontage to the road and screen more recent visitor accommodation additions to the rear. Just next to the hotel and from the same era are the small post office and store buildings (2). An historic schoolhouse and a hall, are located approximately 250m north of the hotel, within a Council reserve.



More recent developments include a small number of stand-alone houses and the relatively large scale 'Benbrae Development' (3), a visitor accommodation complex comprised of multiple stand alone units that take styling cues from minor's huts. A large number of Cardrona's lots remain vacant and, of these, approximately a dozen remain in the ownership of absentee title holders that date back to the gold rush.

1.3 CHARACTER DESIGN PRINCIPLES

The above key characteristics give rise to the following key design values:



Buildings are enveloped by a powerful natural and cultural landscape.

This means:

- Buildings are discrete, small scaled, yet distinctive forms in the landscape
- Buildings reinforce landscape views and viewshafts
- Buildings are surrounded by sufficient space to accommodate mature trees and other vegetation (2 and 4)
- The Village has distinct edges formed by low escarpments to the east and west and the arrival gateways along the highway to both north and south.

The Village is anchored around its highway 'main street'.

This means:

- Commercial and retail development is focussed on the linear strip of the highway that starts at Soho Street and runs south approximately 220m, and on a (future) village green opposite the Cardrona Hotel
- This stretch of the highway must transition into a more pedestrian-focussed street
- Buildings here should relate positively to public spaces, fronting up to the highway and village green
- All development in the Village is well connected to the main street area.

Buildings are simple and appear handmade, based on the traditional 'shed' and cottage forms found in the District.

This means:

- Buildings are composed of a primary volume based on simple, familiar shapes, supplemented by secondary volumes such as verandas, lean-tos and chimneys
- Buildings are oriented and laid out on sites relative to one another to create clearly 'public' fronts with entrances and clearly 'private' spaces, generally at the back
- Larger buildings are composed of collections of primary volumes
- Buildings are constructed and clad in basic, familiar materials (5), primarily timber, stone, plaster and corrugated iron
- Buildings are clearly visible from the street and are not hidden behind high walls or fences
- Colours, signage and fencing reflect the historical context.



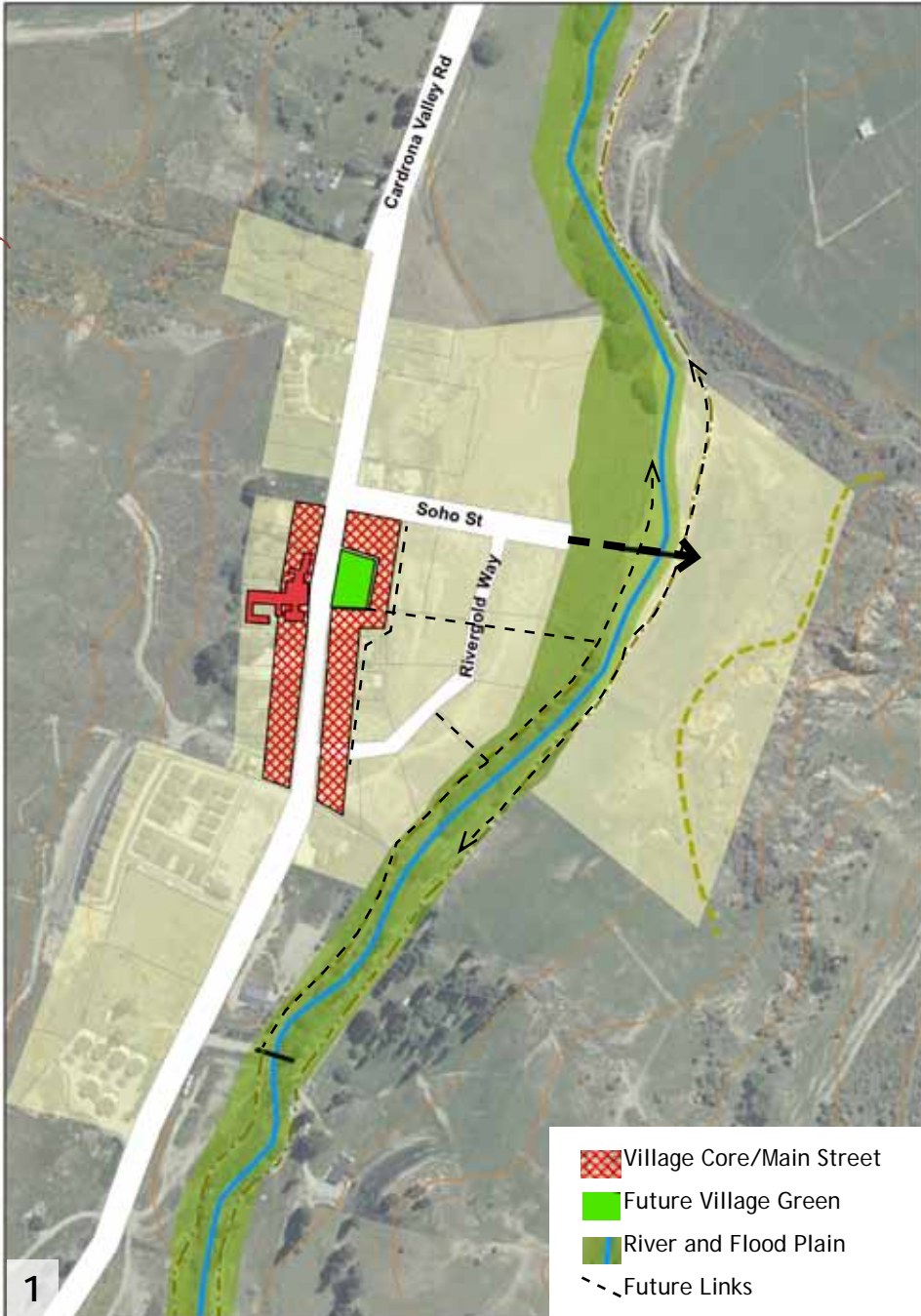

2 Village Structure

The character of Cardrona Village will change significantly as more of the zoned land is developed. When new development is being planned, the following broad considerations should lead the design process:

2.1 STRUCTURING ELEMENTS (1)

Cardrona Valley/Crown Range Road

Cardrona Valley Road transitions to the Crown Range Road at the Cardrona Hotel, the heart of the village. Existing development is located along this north-south road axis. It makes sense for retail and commercial development to coalesce along this strip to benefit from the flow of passing traffic and the existing focal point of the Hotel.

Reinforce the Village Heart

The full length of Cardrona Valley Road within the village boundaries is too long to sustain a vibrant retail frontage. Commercial development should therefore be concentrated on the straight stretch of the road either side of the Hotel and around the envisaged village green.

The Village Green

The proposed village green is intended to be located in a central and visible location in the village heart on the east side of the highway, more or less opposite the Cardrona Hotel, where it would serve as a social focal point for the community and visitors. The current use of this space as Hotel carparking can in the long-term be offset by on-street parallel parking along the road.

Connection to the River

The Cardrona River flows through the valley parallel to the road. Yet it is not currently visible from the road. An opportunity exists to integrate this small alpine valley river into the village fabric. This can be done by:

- Extending Soho Street, up to and over the river
- Creating a lane & vista leading to the river from the village green and/or the main street
- Buildings along the riverside establishing courtyards, frontages and activities overlooking their river facing boundaries while avoiding high walls hedges or fences that create a visual barrier to the river side reserve (2).



Riverside buildings fronting onto river

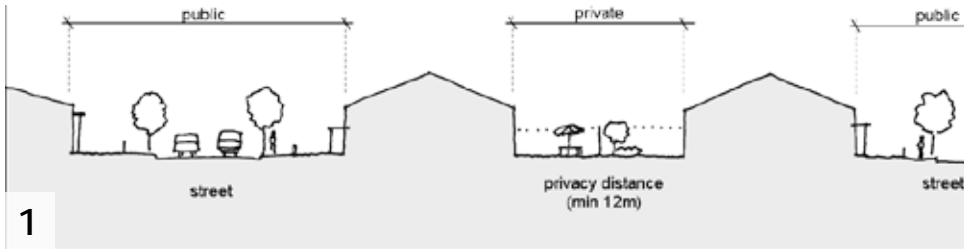

A good subdivision pattern has houses with low fences facing each other across the street. High walls can be used at the rear to provide privacy.

The Movement Network / Subdivision Pattern

The largest undeveloped area zoned for expansion of the village lies to the east of the main road, up to the identified river flood plain, and on the opposite bank, up to the sluice face, once a bridge is constructed. Soho Street provides the most likely link through which to forge this crossing. It is important that the network of streets and lanes created:

- is well-connected and that cul-de-sacs are avoided in order to encourage walking
- forms small tight blocks so as to encourage a traditional village development pattern with dwelling fronts facing other fronts across the street and backs facing backs across back yards (1), while avoiding rear lots
- has relatively straight streets in order to provide clear view shafts to connect to the surrounding landscape, with particular emphasis eastwards towards the stream and the clay cliffs / sluice face
- enables lots orientated east-west, rather than north-south and locating the principal private open spaces to the rear or the side of dwellings to avoid the challenge of residents trying to protect their privacy by high fences or walls on the street edge.

Service Lane

A service lane running parallel to the main street is recommended at approximately 30 to 60m to the east of the 'main street' section of the highway. This would enable deliveries and storage areas, and access to onsite car parking to take place without detracting from the amenity of the street frontage. It could also serve as a rear lane to other activities such as visitor accommodation with a main frontage to a street or lane further east.

2.2 SITE LAYOUT

Main Street Site Design (2)

Development at ground level along the main street strip and around the proposed village green should be retail/ commercial/ tourist related and needs to front onto, and interact with, the main street and village green. To achieve this:

- build up to, or within 2m of, the street (or village green) boundary, except where creating a pedestrian amenity forecourt, such as an outdoor eating area
- create an active edge of shopfronts and entrances facing the street (or village green)
- locate service, storage and any on-site car parking at the rear of the site
- avoid parking forecourts, and where possible vehicular access from the street frontage
- create occasional pedestrian lanes to access activities at the rear of the site and beyond
- align the main walls and rooflines parallel to the street boundary
- avoid parking layouts requiring vehicles to reverse onto Cardrona Valley Road.

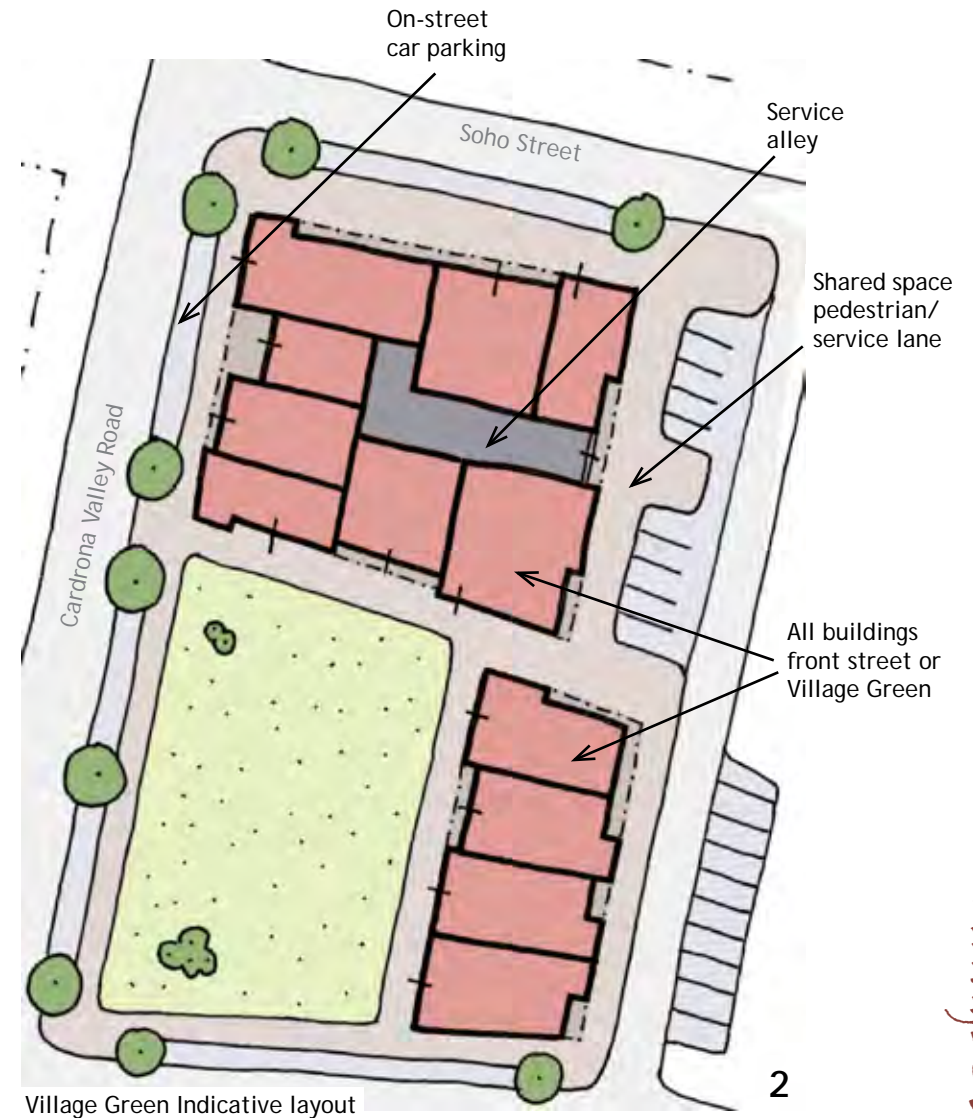

Village Green Indicative layout



Diagrams illustrate traditional residential lot layouts with houses fronting streets, low front fences and recessed garages.

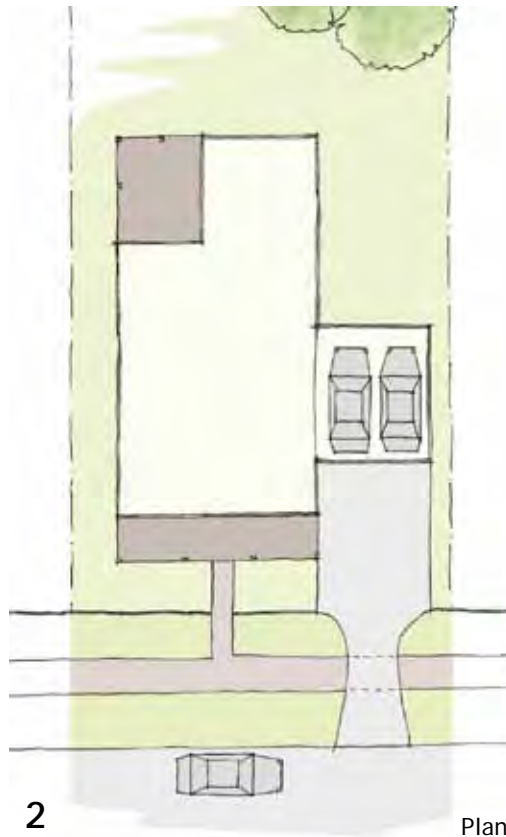

Visitor Accommodation Site Design

A large proportion of future development within Cardrona is anticipated to be for visitor accommodation. The scale of development should respect the fine grained scale fitting for a small rural village and be laid out in a manner that supports an intimate pedestrian streetscape. To achieve this:

- break down larger scale developments into several adjoining footprints
- arrange such footprints in a manner that private and semi-private courtyards are created
- align the main walls and rooflines parallel to the street boundary
- ensure main entrances address and enliven the streetscape with such features as entrance canopies, verandas or porticos
- set accommodation units a minimum 3m from the street frontage or neighbouring sites
- locate on-site parking to the rear or side of the buildings and avoiding parking forecourts
- limit the building footprint to 50% of the site area
- limit the height of visually solid front garden walls or fences to 0.9m
- restrict development to three storeys - the 12m maximum height for visitor accommodation buildings within the zone enables the expression of traditional gable roof forms, but is not intended to enable a fourth storey
- avoid parking layouts requiring vehicles to reverse onto Cardrona Valley Road.

Residential site design (1 and 2)

In addition to visitor accommodation, future growth can be anticipated to attract people who choose to live in Cardrona for the attractions and amenities afforded by the setting, as well as for work opportunities. It is important that future residential development supports the desired traditional village structure. Therefore:

- create discrete individual dwelling units
- create public fronts facing the street and private backs
- provide a small front yard for each unit that can allow visitors to cross a threshold (front gate), move through a semi-private space, before arriving at the front door to the private realm
- include a transitional structure, such as an entrance canopy, porch or veranda at the front entrance facing the street
- locate a kitchen, living or dining space with a window facing the street
- plan the building layout so that the main living area opens directly to a sunny outdoor living space
- locate dwellings at least 3m from street fronts and 1m from side or rear boundaries
- limit the building footprint to 50% of the site area
- locate garages further to the rear of the site than the main frontage of the dwelling with straight line access from the road
- where possible, combine driveways to rear parking with neighbours
- limit the height of visually solid front walls or fences to 0.9m and use traditional materials and designs including schist walls and picket fences. Occasional high hedges are encouraged
- avoid parking layouts requiring vehicles to reverse onto Cardrona Valley Road.

Earthworks

The natural contour of the land should be respected and should not be significantly disrupted (3). To achieve this:

- minimise earthworks and avoid excessive cut and fill in all land modifications for subdivision, and site works to establish building platforms, driveways, streets, and lanes; restrict retaining walls to a maximum height of 2.5m
- when retaining ground higher than 2.5m, a second retaining wall should be set back a minimum of 3.5m from the first and should also be restricted to 2.5m in height (4).



Excessive cut into natural contours

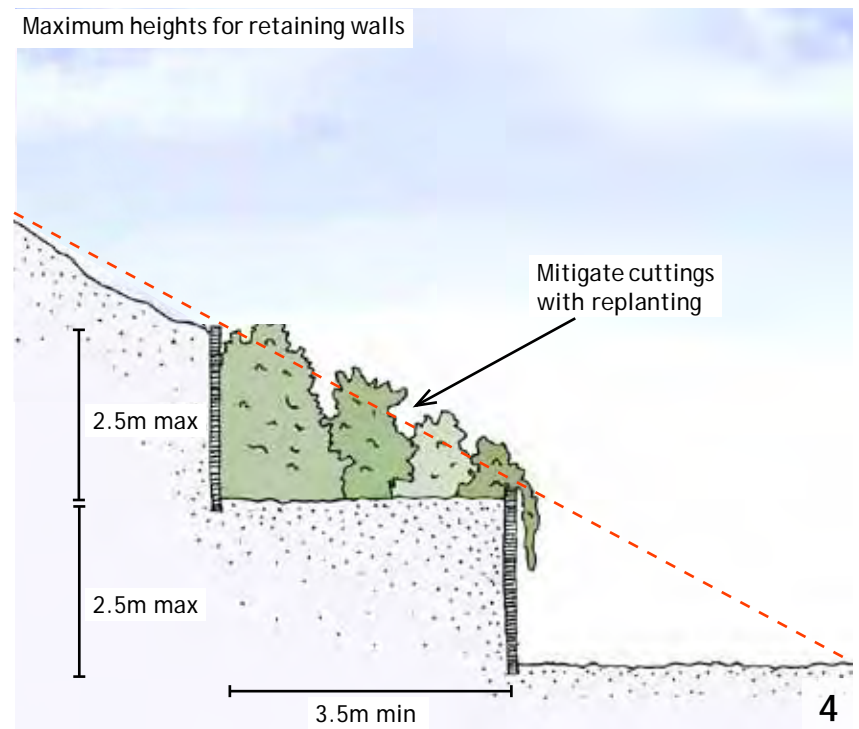

Maximum heights for retaining walls



3 Building Design

3.1 BUILDING CHARACTER

A ‘key community outcome’ identified in the Cardrona 2020 Community consultation process in 2003 is “to enhance the historic theme in the main Cardrona township area and for all new buildings to respect the existing character and scale of the township”. Relatively little is left of Cardrona’s historic building fabric. In order to find appropriate design cues for the types of buildings anticipated in Cardrona, it is necessary to search wider in the Queenstown Lakes District. The buildings of the early settlers, in particular the rural shed (1) and the cottage (2) provide examples of buildings that sit well in the dramatic landscapes and can be adapted to contemporary uses without losing the defining features of their identity. These building types are based on simple, easy to construct forms.

The shed lends itself more readily to Cardrona where there is an anticipated demand for visitor accommodation and the zone rules enable buildings up to 12m high. Early examples of large sheds include the former three storied Brunswick Flour Mill at Kawarau Falls, and the Arranmore Stable next to the runway at Queenstown airport. Recent examples of contemporary interpretations of the shed are the Club House at Jacks Point (3) and the Amisfield winery near Lake Hayes.

Early cottages were small and usually single storied, consisting of a small shed-like primary volume adorned by lesser secondary elements such as a veranda, lean-to and chimney. However this building type can also successfully be adapted to the larger sizes demanded by contemporary uses through the aggregation of several primary and secondary elements. Alternatively a grouping of discrete small cottages can collectively form a visitor accommodation complex. In such instances it is important that a traditional neighbourhood site layout is adhered to in accordance with the residential site design principles above, and the repetition of the same or similar unit type throughout the complex is avoided.

Traditional Building Components

The primary element of the shed (4) is composed of:

- a rectangular footprint up to 20m long and 8m wide
- a gable roof pitched between 25 to 40 degrees with minimal or no eave overhang
- up to a maximum of 3 storeys within a maximum height of 12m
- few, if any secondary elements adorning the primary form.

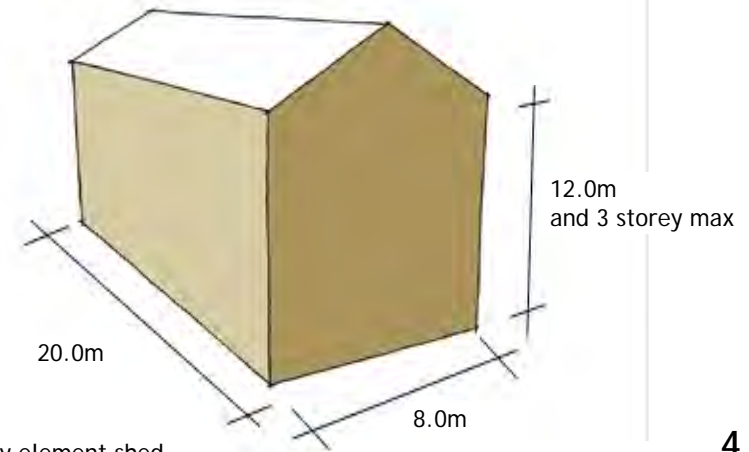

Primary element shed

The primary element of the cottage (5) is composed of:

- a rectangular footprint up to 12m long and 5 m wide
- hipped or gable roofs pitched between 25 to 40 degrees with minimal eaves
- usually one storey, but occasionally two storeys within a maximum height of 8m.

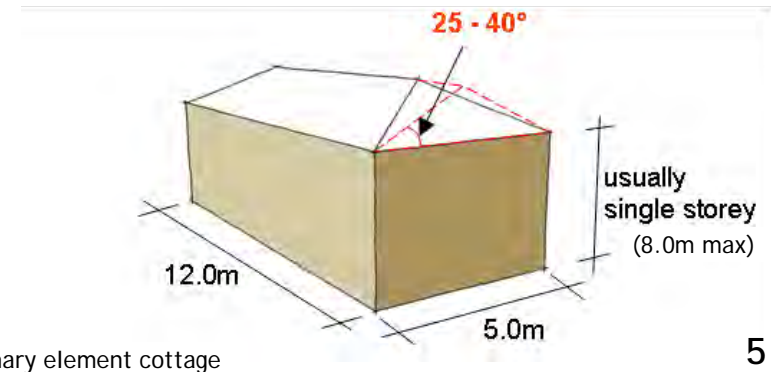

Primary element cottage

Secondary elements (6) include:

- Lean-tos of a width up to 2/3rds the width of the primary structure added to any side with roof pitches between 8 and 20 degrees
- Strong fireplaces and chimneys typically located at the gable end
- Verandas and porches (usually in lean-to form).

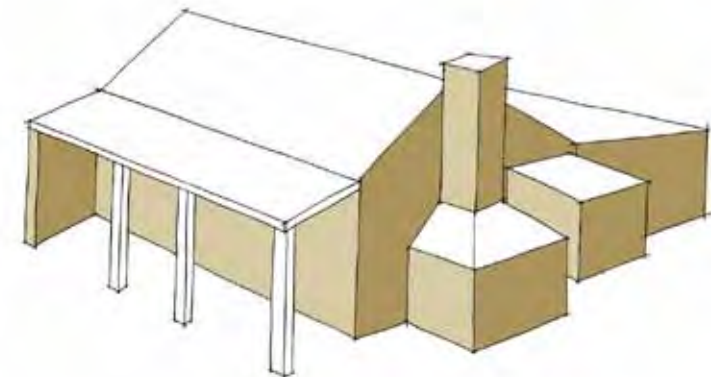

Cottage combining primary and secondary elements



Two primary forms and secondary link

Larger Buildings

- Larger buildings can be composed of groups of adjoining primary elements (1) and secondary elements
- Each primary element should have a discrete roof form
- Exact repetition should be avoided with subtle variations introduced to the forms
- Arrange the primary volumes to define usable outdoor spaces.

Main Street and Village Green Buildings (2)

Along the 210m stretch between Soho Street and the change in direction of Cardrona Valley Road just north of the Rivergold Way intersection, buildings may be built up to the street boundary, but should not exceed two storeys and 8m in height within 15m of the street frontage.

To activate the street façade of main street and village green buildings:

- use simple, familiar building forms (3) built up to, or within two metres of the street or village green boundary
- form shop fronts and entrances along the street edge
- add verandas and shopfront parapets(avoiding overstated support structures)
- provide between 40% and 60% of openings (windows and doors) to the below veranda component of the façade
- express the façade depth by avoiding windows flush with the cladding (2)
- provide level access between the footpath and the internal ground floor.



Main street corner building

The Cardrona Hotel

- Facades of new buildings should not be overly elaborate so as to compete with Cardrona's iconic signature building. This collection of single storey buildings and the associated historic post office and store need to be set apart from other development in order that this distinctive form is not overwhelmed by any new neighbours
- A gap of at least 3m should be provided between these historic buildings and any new development.

Residential Buildings

New residential buildings should be composed of the primary and secondary elements of the traditional cottage, and on occasions the traditional rural shed with a maximum height of two storeys and 8m (4).

The primary element of each house should address the street in the following manner:

- The street façade should be parallel to the street boundary and incorporate the entry door and windows
- Where a veranda facing the street is proposed it should occupy the full width of the street façade. Details such as brackets and post mouldings should be restrained and simple
- The components of the veranda should not be larger than required for structural support. (150 x 150mm posts would be oversized)
- Symmetry and non-functional ornaments should be restricted to the street façade.

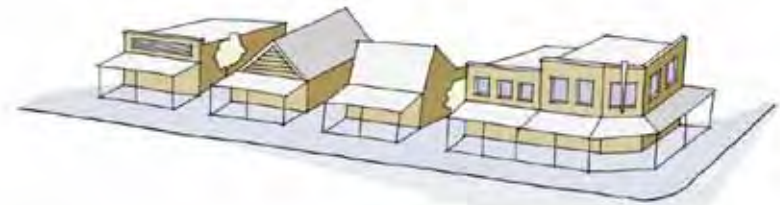

Archetypal main street building forms

3



The primary elements of the house should address the street

4



1

Visitor Accommodation Buildings

Visitor accommodation developments take on a number of different formats from single multi-unit buildings to groupings of individual units and an associated office unit. These formats can readily be adopted to fit within the constraints of the traditional rural shed or cottage building types when treated as aggregations of cells comprising primary shed or cottage components (1).

- An aggregation of primary shed forms could accommodate multiple units as well as dining, lobby and conference facilities, whereas a grouping of individual cottage forms lends themselves to accommodating individual units
- Visitor accommodation developments should feature a clearly defined main entry facing the street and parallel to the street boundary
- Groupings of separate buildings should each address the public streetscape or laneways within the private development in a manner set out above for residential buildings
- Visitor accommodation buildings should not exceed three storeys in height, however groupings of cottage forms should generally be single storied and should not exceed two storeys.

Signage and Shop Front Lighting

Design signage and lighting as an integral part of the building façade (2). This will help reduce visual clutter and maintain the integrity of the overall site design.

- Signage needs to reference the historic Cardrona character (4), with regard to size, font style and colours
- All signage should be integrated into the architecture of the building
- Above ground floor signage should be restricted to building names in cut out lettering or painted directly onto the façade
- Avoid ubiquitous corporate signage, colours and 'chain brand' architecture
- Buildings occupied by commercial franchises, nationwide or international businesses should show respect for their context
- Shop front lighting (and pedestrian canopy lighting) needs to maintain night time pedestrian amenity and safety. Design with restraint so as to avoid a 'service station' level of over-saturation
- Avoid light spill.



3



4



3.2 MATERIALS

Materials and finishes should be complimentary to the traditional palette of materials found in the District. Respecting this limited palette offers an effective way of generating cohesiveness. The District's early buildings were built from the materials at hand, which were typically processed to the minimum extent necessary (1). The construction process involved crafting the buildings with simple hand tools, with little pre-fabrication and components were often recycled.

Materials Appropriate for Cardrona

Those materials traditionally used in Cardrona should form the basis for evaluating which new materials are acceptable.

- Recycled and re-used materials contribute an aged look and in addition enhance the sustainability of the structure by avoiding the embodied energy costs of new material
- Buildings should typically be constructed in a limited palette of materials, with each building element, be it primary or secondary, clad in a single material
- New mass production technologies can easily conflict with such a traditional approach and their use should therefore be constrained
- Replicating traditional materials is often unsuccessful.



Timber (3)

Timber was the primary structural and cladding material of the early settlers in Cardrona. The remaining historical buildings are all clad in painted weatherboards with either bevel back or rusticated profiles.

- Much of the expression of the façade arises from the trim, including window and door facings and boxed corners, which are typically wide timber facings
- Tongue and grooved boarding is the traditional material for areas such as veranda soffits
- Timber shingles were also a traditional roofing material and are appropriate
- Contemporary imitations, in composite material, aluminium and plastic can replicate the traditional profiles however never acquire the subtleties and character of aged timber and, hence, should be avoided.

Mortared Schist (4)

There is a strong Western and Central Otago tradition of building in local schist, traditionally featuring a smeared earth/ lime mortar joint.

- This style is recommended for all stone external walls of buildings and is also effective for boundary walls when schist predominates on the associated building
- Schist should not be used for secondary elements (other than chimneys), and additions, 'feature walls', columns or plinths unless it is also used to clad the primary form.



Cardrona Community Hall

3



A contemporary mortared schist shed

4



Corrugated Iron (1)

Corrugated iron is the longstanding roofing material of preference. Traditionally roofs remained unpainted, with the galvanised iron weathering to a mat patina.

- Galvanised steel is a reasonably durable product in the dry local environment and remains available
- Painted or 'colorsteel' roofs have a sheen and consistency of appearance that lacks the character of the traditional weathered appearance, however new paint colours are now available with low reflectivity that more closely replicate the duller mat quality of weathered metal
- Zincalume is too bright and reflective and should not be used.

Plaster (2)

There is a tradition in the District of using plaster to bag stonework, and in more recent times to disguise the block module in concrete and produce a monolithic surface. This can effectively create a sympathetic contrast to the texture of timber, stonework or corrugated iron.

- Where used, plaster should be either limewashed or matt painted.



Materials Not Appropriate for Cardrona

Building materials that try to look like something they are not, are inappropriate as construction or cladding materials, e.g. fake stone or monolithic finishes over composite sheet cladding, pressed tile roofing, slim profile schist and fibre cement sheet cladding.

3.3 APPLYING COLOUR

The local flora and geology of the Cardrona Valley offer a wide and varied colour palette. It is important that colours applied to the built form should complement these colours as well as respecting the colour palette of traditional buildings in the District (3 and 4).

Traditional buildings in the region feature subdued colour, particularly for the larger areas of cladding, with stronger rustic colours used for trim. Roofs are predominantly grey, rustic red or rustic green. The remaining heritage buildings in Cardrona all feature cream cladding, with strong darker colours used to express the architectural trim and detail. Early photographic records indicate some earlier buildings were unpainted.

- Provide for timeless colours, not what is fashionable. Heritage colour charts from Resene, Aalto and other manufacturers provide suitable guidance (avoid colours brighter in hue than appear on these charts)
- Consider developing a basic palette for each development which can be varied between buildings. No more than 40% of the buildings in any single large development should have the same colour scheme
- Avoid relying too greatly on muted colours, as it can simply make a development appear depressed and faded (5). Splashes of strong colour can greatly enliven a streetscape
- Avoid excessive use of corporate colours that turn buildings into signage
- Solar heating panels may breach reflectivity levels over small area on roofs.



4 Public Open Space Design

4.1 CARDRONA VALLEY ROAD



Beyond the Town Boundary

As one travels through the valley, the power of the landscape lies in the simple clarity of the transition from the natural alpine grasslands of the valley walls to the modified rural landscape of the valley floor, including the sluice faces visible around Cardrona. This needs to be protected from visual intrusion. Minimise the visual impacts of man-made structures on the road edge such as utility poles and signage. For example the new power poles recently installed up Cardrona Valley Road have a greater visual impact than the old posts that are of a smaller scale and have an historical visual reference.

Entrances to the Village

The township features a variety of established exotic trees associated with its early settlement. However street trees along the road itself are restricted to the clusters at each end that signify the entrances (1 and 2). Upright columnar exotic varieties are effective in this and other locations however the use of native beech is out of context. It is important that the road clearly transitions from highway to village street at these entrances.

- Reinforce and enhance the existing groves of columnar exotic trees that signify the entrance points to the village and mark the transition from the open road to a 70kph zone, while phasing out existing beech trees
- Narrow the carriageway between the village entrances and the village core to slow the traffic and clearly indicate a change of road character
- Introduce a line of street trees (such as fastigiata Oak or Hornbeam) at intervals of between 15 and 30m as permitted by underground services along both sides of the road from the village entrances at

both ends and up to the identified village core, to clearly mark the linear extent of the town, enhance containment of the road edge and assist in traffic calming. Power lines along the eastern side of the road need to be undergrounded and their poles removed

- Enable parallel parking along each side of the road on a grass swale edge
- Complete informal 1.8 to 2.2m wide pathways along the west side of the road, using crushed gravel or limestone. Avoid the use of a raised kerb and channel; instead use concrete nibs under road edges to avoid edge break. Separate path from parking/swale by at least one metre
- Introduce street lights at regular intervals between street trees - see 'Palette of Materials' section
- Avoid introducing excessive clutter by way of traffic and parking signage or bollards.

Transition Zone

- Introduce a transition zone on either side of the village core, between the 70kph zones and the 'mainstreet' component of the village core
- Create two new thresholds between the 70kph zone and a central 50kph zone by locating the last two fastigate varieties directly opposite one another and close as possible to the carriageway and vary the paving treatment to a rough cobble effect
- Introduce a line of smaller street trees from the varieties (other than fastigiate) on page 28 at between 15 and 30m spacings
- Enable parallel parking along each side of the road within grass swales
- Continue the line of street lights from the town boundary thresholds
- Avoid introducing excessive clutter by way of traffic and parking signage and bollards.

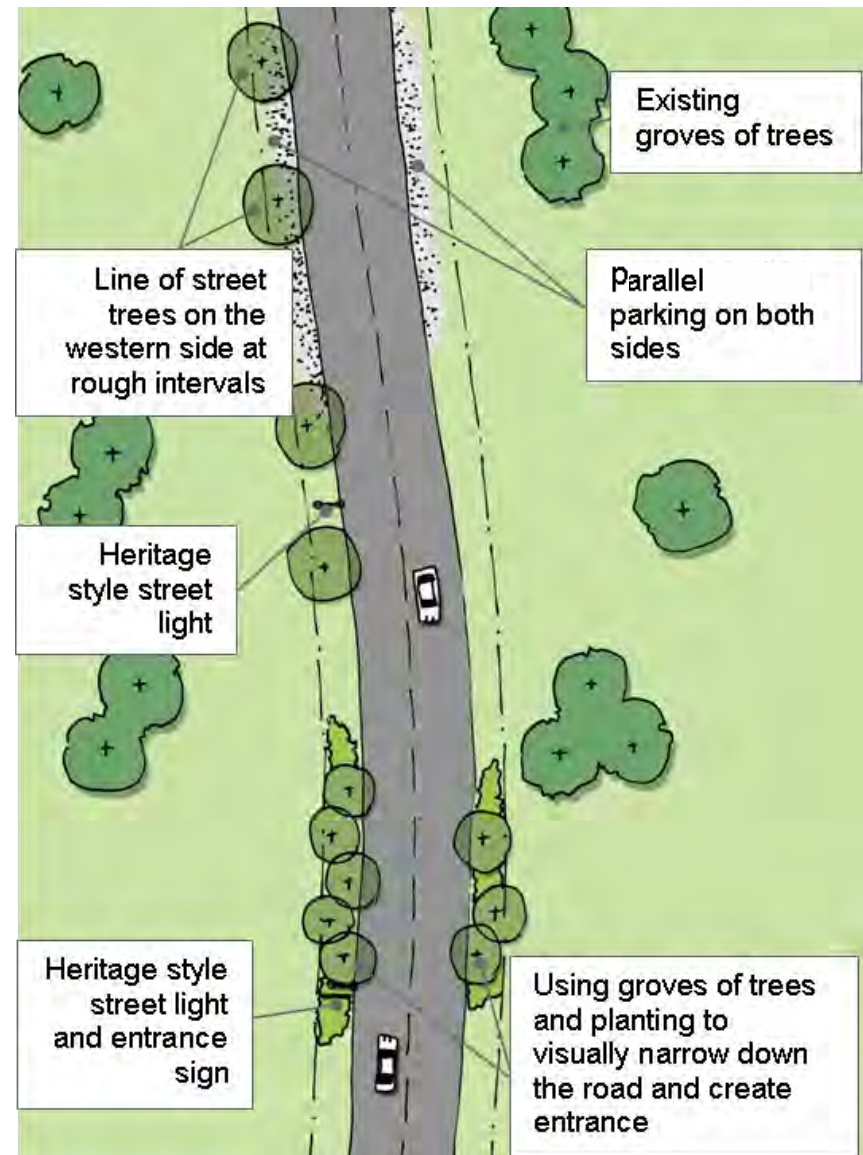

Entrance to village

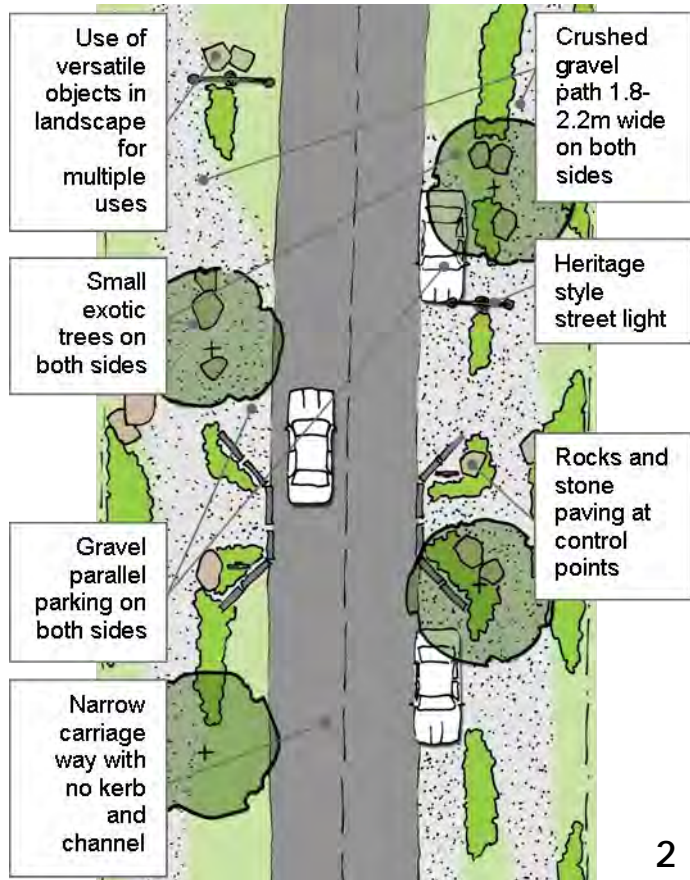

The Village Core

- A distinct and more intense character is sought through this section to reinforce its role as the village focal area. Further narrow down the carriageway through the village core to encourage traffic speeds safe for informal crossing (approximately 30kph). Avoid using a flush median to keep the width constrained
- Underground the existing overhead power lines along the east side of the road, in an alignment that avoids the proposed alignment of street trees below
- Enable parallel parking in compacted gravel swales on both sides of the road, where the reserve width permits. However exclude parking in front of the Hotel frontage
- Introduce smaller exotic deciduous trees (distinct from entrance and transition zones) to both sides of street at 15 to 20m spacings between parallel carparks (incorporating irrigation) however keep clear of stretch of heritage buildings along west side
- Create crushed gravel pathways without raised kerbs along both sides of the road
- Continue the line of street lights from the transition zone, except in the immediate vicinity of the hotel where existing heritage lamps are retained (1)
- Integrate the placement of large rocks into the landscape and consider using this at control points for pedestrian crossing area in front of the hotel
- Limit streetscape furniture materials to timber, stone and steel
- Use black for the colour of the light poles and limit the colour of other furniture to the natural colour of the construction material such as timber and stone
- Avoid visual clutter including overstated and/or superfluous bollards and road signage inappropriate in the village core.

4.2 VILLAGE GREEN (3)

A village green is proposed opposite the Cardrona Hotel and is envisaged as an informal open space clearly defined by the active edges of buildings around its perimeter.

- Design to accommodate multiple outdoor community uses from picnics, outdoor market days and community festivities
- The predominant surface should be lawn with low alpine planting and small scale exotics (see Tree Schedule below) for edge definition prior to realisation of active built edges
- Further reinforce edges and create informal seating using large locally sourced stones.



Arrowtown Village Green

3

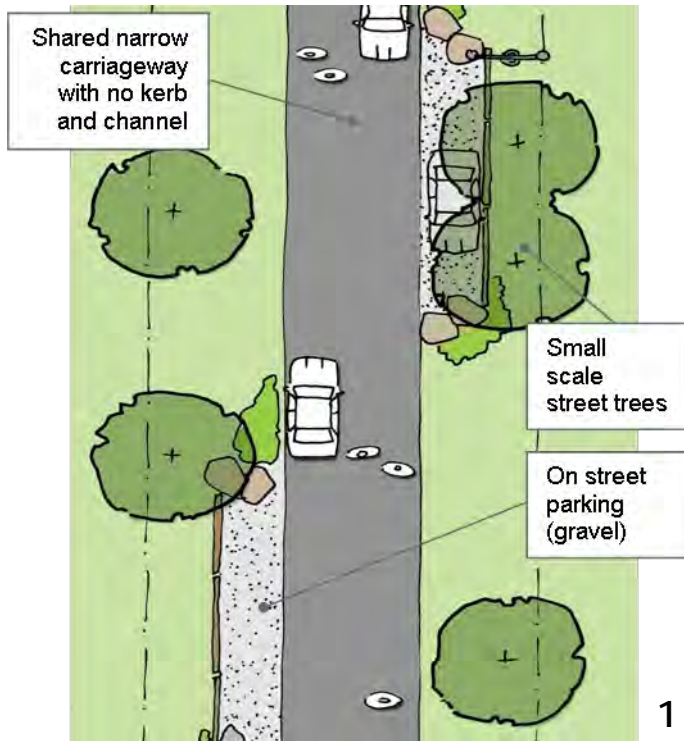

4.3 SECONDARY STREETS AND LANES

The movement network should be extended from Cardrona Valley Road as a series of intimately scaled rural village lanes conducive to walking as opposed to urban roads. The following elements should be addressed (1):

- Provide a low speed environment for vehicles by reducing the width of the carriageway
- Create an informal character and avoid raised kerb and channel
- Consider lanes that are shared by pedestrians and vehicles
- Include on-street car parking on lanes to minimise the amount of on-site car parking and to use space efficiently, as space for moving is also used for manoeuvring. These spaces could be formed of semi-grassed permeable pavers or crushed gravel, to avoid the need for painted traffic markings
- Although a rural 'feel' is envisaged, aim for a high level of amenity, including street furniture and lighting. Focus on quality and robustness in materials and finishes and avoid over-design or elaborate detail. Include street trees of a scale appropriate to the narrow intimate scale of the lanes. Consider a rustic style of lighting (2).

4.4 RIVERSIDE LANDSCAPE (2)

The Cardrona River which flows parallel to the road through the valley is the principal natural feature within the village. Its wide flood zone, in particular along the western bank, provides an opportunity to create a public amenity area, reinforcing the close relationship between the village and its dramatic setting.

- Focus on retaining a wilderness quality to this area while enabling public access through narrow informal paths
- Base the planting palette on species currently occurring in the river flats and wetlands, however use other willow species than crack willows.

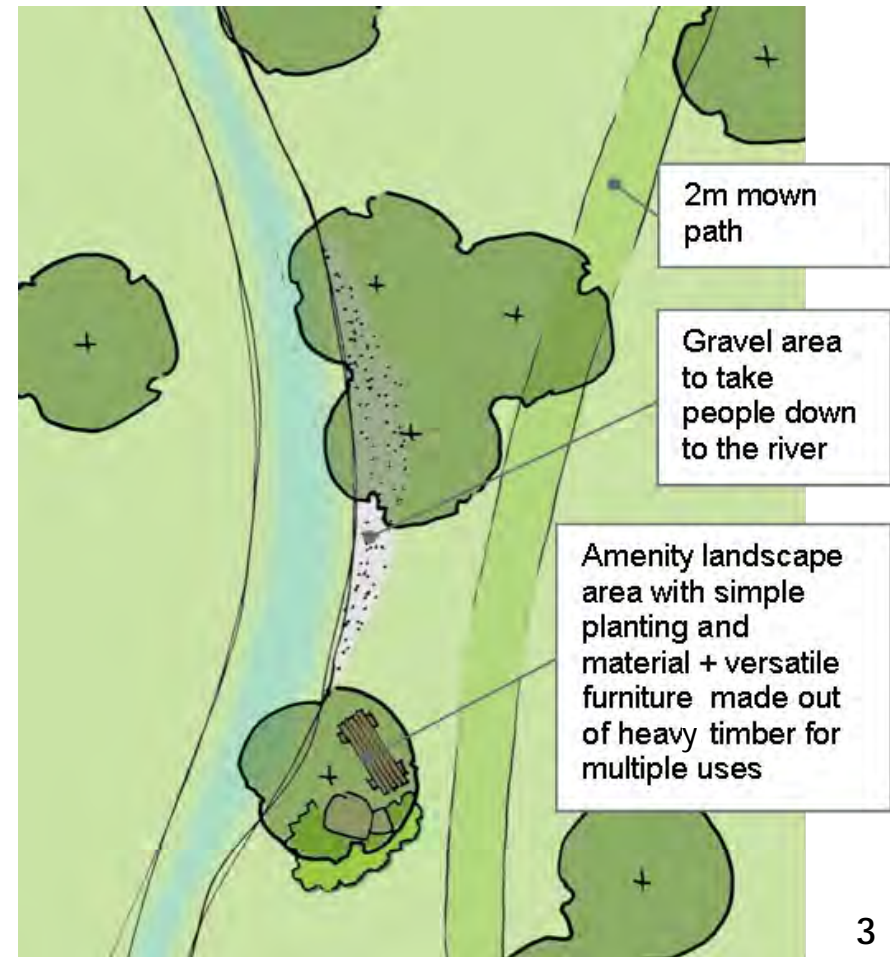





4.5 LANDSCAPING AND PLANTING IN CARDRONA VILLAGE



The following tree and plant species are appropriate for the public realm in and around the Cardrona Village.





Type	Species	Common name	Height	Historic
Exotic trees	Aesculus hippocastanum	Horse Chestnut	10m+	Yes
	Quercus robur fastigiata	Fastigiated Oak	15 - 20m	
	Carpinus betulus fastigiata	Fastigiated Hornbeam	9 - 12m	
	Corylus avellana	Hazelnut	3 - 7m	Yes
	Cornus capitata	Evergreen Dogwood	7 - 14m	
	Fraxinus ornus	Manna Ash	9 - 15m	
	Pyrus	Flowering Pear	5 - 10m	
	Juglans regia	Common Walnut	10m+	Yes
	Malus (old varieties)	Crab Apple	4 - 7m	Yes
	Quercus robur	German Oak	10m+	Yes
	Sorbus aucuparia	Rowan	8m	Yes
Native trees	Hoheria lyallii	Mountain Ribbonwood	3m	
	Nothofagus solandri (var. cliffortoides)	Mountain Beech		Yes
	Sophora microphylla	Kowhai	4m	



Type	Species	Common name	Historic
Hedges	Cupressus macrocarpa	Macrocarpa	Yes
	Acer campestre	Field Maple	Yes
	Buxus sempervirens (& varieties)	Box	Yes
	Carpinus betulus	Common Hornbeam	
	Chaenomeles x Hybrid	Flowering Quince	Yes
	Coprosma propinqua	Mikimiki	
	Coprosma rugosa	Coprosma	
	Corylus avellana	Common or European Hazel	Yes
	Corokia cotoneaster	Zig-Zag Shrub	
	Crataegus monogyna	Hawthorn	Yes
	Cupressus macrocarpa	Macrocarpa	Yes
	Escallonia x exoniensis	Escallonia	Yes
	Fagus sylvatica	European Beech	
	Lavandula angustifolia	Lavender	Yes
	Lonicera nitida	Honeysuckle	Yes
	Lonicera pileata		
	Prunus laurocerasus	Cherry Laurel	Yes
	Rosmarinus officinalis	Rosemary	Yes
	Taxus baccata	Common Yew	Yes
	Taxus baccata 'Fastigiata'	Columnar Yew	Yes

4.6 PALETTE OF MATERIALS - STREETS LANES AND VILLAGE GREEN

Footpaths, Streets and Walkways				
Description	Crushed local aggregate or hoggin, no raised kerbs	Grass swales with Cyprus Oaks at 20 to 40m centres	Crushed local aggregate with medium sized deciduous trees at approx 20m centres	Crushed local aggregate with small deciduous trees at approx 20m centres
Location	All footpaths	Cardrona Valley/Crown Range Rd Swales inside 70kph zone	Swales inside 50kph zone	Cardrona Valley/Crown Range Rd swales, 'mainstreet' section

Footpaths, Streets and Walkways			
Description	'Crazy paving' schist flagstones in concrete or mortar.	Chip seal and grass swales	Crushed local aggregate or grass
Location	Pedestrian crossings	Lanes with vehicular access	Riverside walkways

Street furniture				
Description	Standard rubbish bin	Bike stand	Bollard	Street Light We-ef lamp on Wilson pole
Location	All locations	All locations	All locations	All locations

Street furniture		
Description	Standard park seat	Feature rocks
Location	Village Green and riverside	As required



QUEENSTOWN
LAKES DISTRICT
COUNCIL

